

S5 - Vocabulaire

Génération de volumes :

Extrusion :

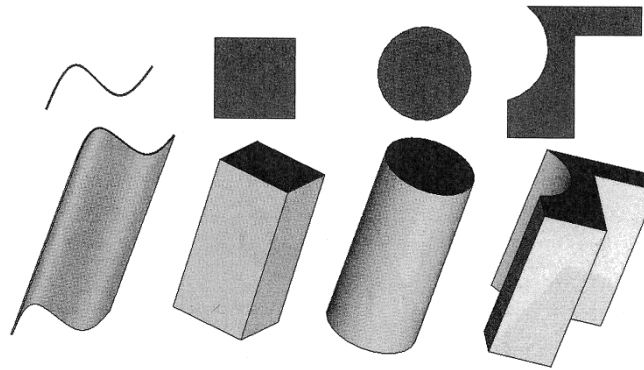

Révolution :

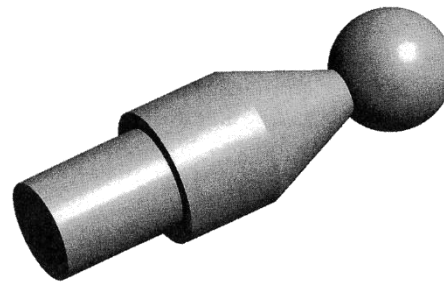

Modèle géométrique

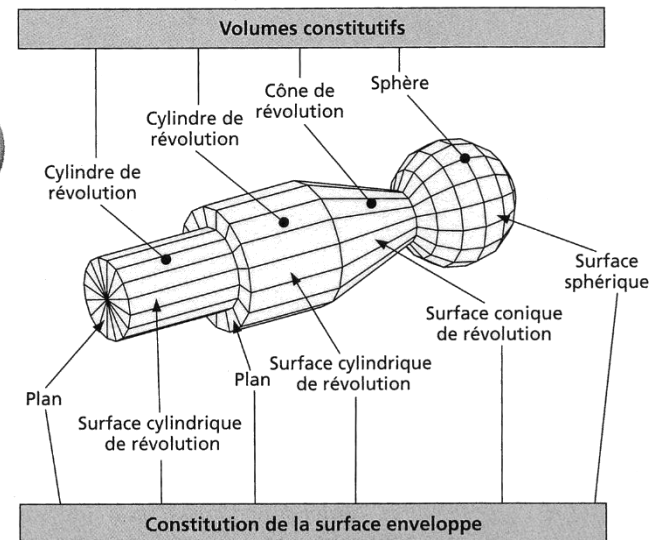

Volumes élémentaires :

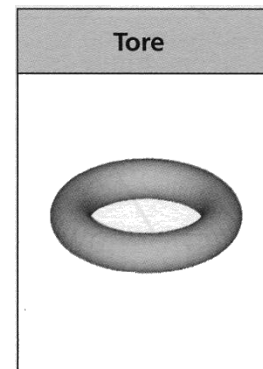
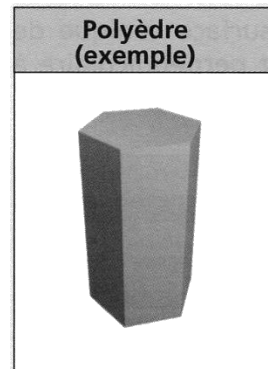
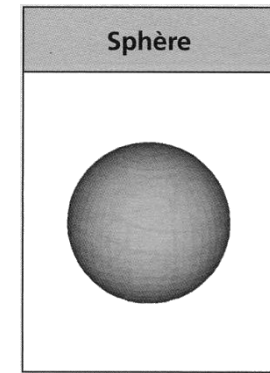
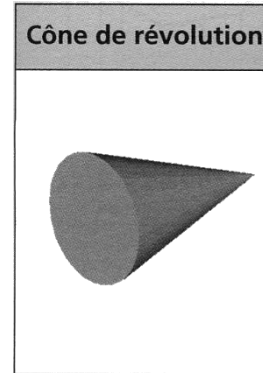
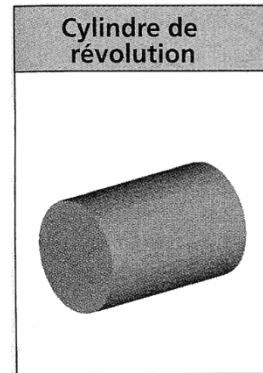
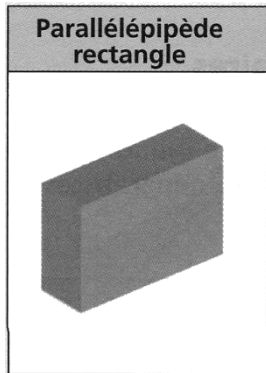

Formes usuelles :

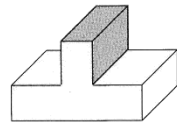

Tenon

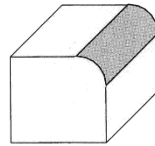

Arrondi

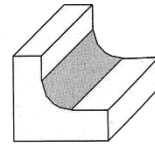

Congé

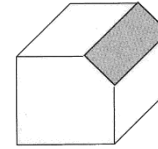

Chanfrein

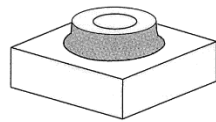

Bossage

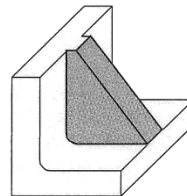

Nervure

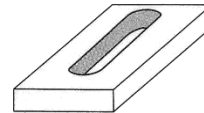

Trou oblong

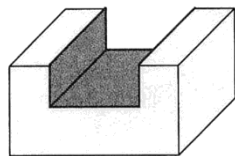

Rainure
droite

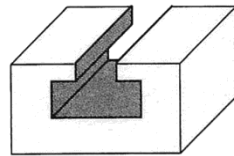

Rainure
en té

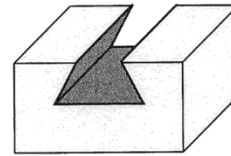

Rainure en
queue
d'arronde

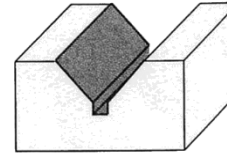

Rainure
en vé

Formes usuelles sur les arbres :

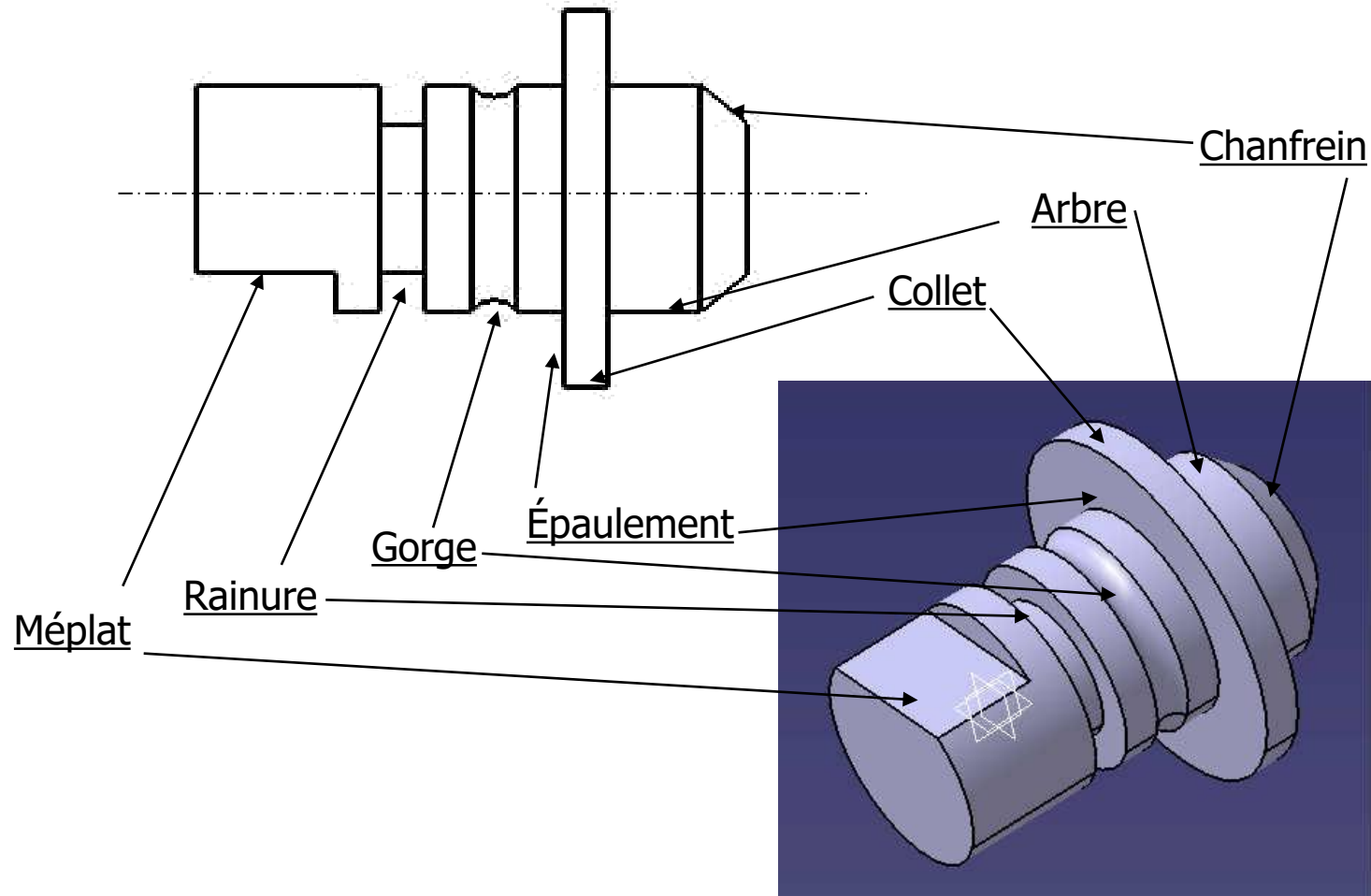

Formes usuelles sur les alésages :

